

M4099D Image Scanner

Reference Guide

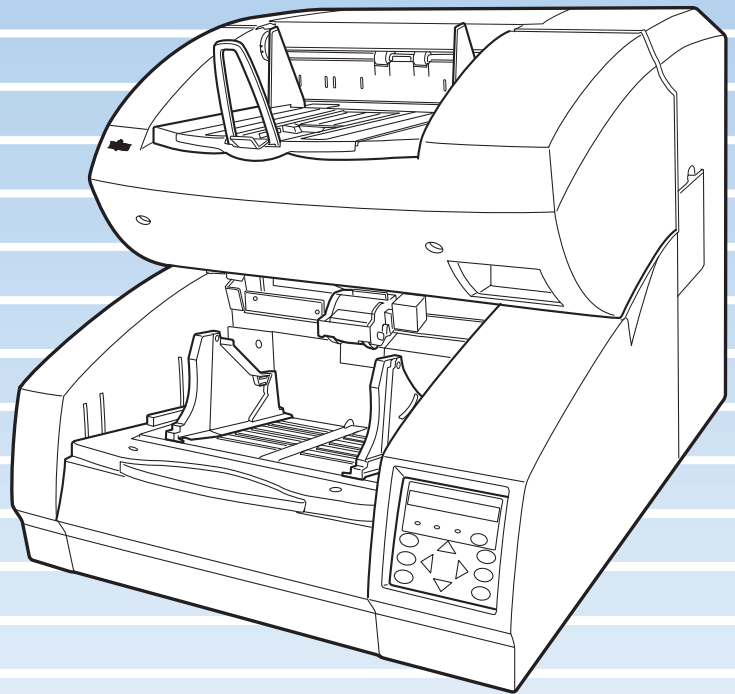

FUJITSU

Edition	Date published	Revised contents
01	December, 1999	First edition
02	January, 2000	Illusts and descriptions changed about how to open the upper sheet guide assembly and the pad (assembly) and other parts. Procedures for Troubleshooting partially corrected. Typos corrected.

This equipment has been tested and found to comply with the limits for a Class A digital device, pursuant to Part 15 of the FCC Rules. These limits are designed to provide reasonable protection against harmful interference when the equipment is operated in a commercial environment. This equipment generates, uses, and can radiate radio frequency energy and, if not installed and used in accordance with the instruction manual, may cause harmful interference to radio communications. Operation of this equipment in a residential area is likely to cause harmful interference in which case the user will be required to correct the interference at his own expense.

This digital apparatus does not exceed the Class A limit for radio noise emissions from digital apparatus set out in the Radio interference Regulations of the Canadian Department of Communications.

Le présent appareil numérique n'émet pas de bruits radioélectriques dépassant les limites applicables aux appareils numériques de la classe A prescrites dans le Règlement sur le brouillage radioélectrique dicté par le ministère des Communications du Canada.

Maschinenlärminformationsverordnung 3. GSGV, 18.01.1991: Der arbeitsplatzbezogene Schalldruckpegel beträgt 70dB(A) oder weniger gemäß ISO 7779.

The contents of this manual may be revised without prior notice.

All Rights Reserved, Copyright © 1999, 2000 FUJITSU LIMITED.
Printed in Japan.

No part of this manual may be reproduced in any form without permission.

Please send your comments on this manual or on Fujitsu products to the following addresses:

North American contact:

FUJITSU COMPUTER PRODUCTS OF AMERICA, INC.

2904 Orchard Parkway, San Jose.
California 95134-2009, U.S.A.
Phone: (1-408) 432-6333 Fax: (1-408) 894-1709
HOME PAGE: <http://www.fcpa.com/>

FUJITSU CANADA, INC.

2800 Matheson Boulevard East, Mississauga,
Ontario L4W 4X5, Canada
Phone: (1-905) 602-5454 Fax: (1-905) 602-5457
HOME PAGE: <http://www.fujitsu.ca/>

European contact:

FUJITSU EUROPE LTD.

2, Longwalk Road, Stockley Park, Uxbridge,
Middlesex UB11 1AB, England
Phone: (44-181) 573-4444 Fax: (44-181) 573-2643
HOME PAGE: <http://www.fujitsu-europe.com/>

FUJITSU DEUTSCHLAND GmbH.

Frankfurter Ring 211, 80807 München, Germany
Phone: (49-89) 32378-0 Fax: (49-89) 32378-100

FUJITSU ITALIA S.p.A.

Via Nazario Sauro, 38, 20099 Sesto S,
Giovanni (MI), Italy
Phone: (39-2) 26294-1 Fax: (39-2) 26294-201

FUJITSU NORDIC AB

Kung Hans Väg 12, S-192 68 Sollentuna, Sweden
Phone: (46-8) 626-4500 Fax: (46-8) 626-4588

FUJITSU ICL ESPAÑA, S.A

Almagro, 40 28010 Madrid, Spain
Phone: (34-1) 581-8000 Fax: (34-1) 581-8300

FUJITSU FRANCE S.A.

1, Place des Etats-Unis, SILIC 310,
94588 Rungis cedex, France
Phone: (33-1) 4180-3880 Fax: (33-1) 4180-3866

Australian contact:

FUJITSU AUSTRALIA LTD.

Fujitsu House 2 Julius Avenue
North Ryde N.S.W. 2113, Australia
Phone: (61-2) 9776-4555 Fax: (61-2) 9776-4556
HOME PAGE: <http://www.fujitsu.com.au/>

Asian contact:

FUJITSU HONG KONG LTD.

10/F, Lincoln House, Taikoo Place,
979 King's Road, Island East, Hong Kong
Phone: (852) 2827-5780 Fax: (852) 2827-4724
HOME PAGE: <http://www.fujitsu.com.hk/>

FUJITSU KOREA LTD.

6th Fl., Korea Financial center building,
Yoido-Dong 23-6, Young DUNGPO-gu, Seoul,
Republic of Korea
Phone: (82-2) 3787-6000 FaX: (82-2) 3787-6029
HOME PAGE: <http://www.fujitsu.co.kr>

FUJITSU COMPUTER (SINGAPORE) PTE. LTD.

20 Science Park Road, #03-01, Tele Tech Park
Singapore Science Park II,
Singapore 117674, Republic of Singapore
Phone: (65) 777-6577 Fax: (65) 771-5669
HOME PAGE: <http://www.fsl.com.sg/>

FUJITSU TAIWAN LTD.

8F Hung Tai Center, 168-170
Tun Hwa North Road, 1st Sec. Taipei, Taiwan, R.O.C.
Phone: (886-2) 2545-7700 Fax: (886-2) 2717-4644

FUJITSU SYSTEMS BUSINESS (MALAYSIA) BHD.

Fujitsu Plaza, 1A Jalan Tandang 204, P.O. Box 636
Jalan Sultan 46770, Petaling Jaya, Selangor Darul
Ehsan, Malaysia
Phone: (603) 7783-3888 Fax: (603) 7783-0888

FUJITSU SYSTEMS BUSINESS (THAILAND) LTD.

12th Fl., Olympia Thai Tower,
444 Rachadapisek Road, Samsennok,
Huay Kwang, Bangkok 10320, Thailand
Phone: (662) 512-6066 Fax: (662) 512-6068

FUJITSU PHILIPPINES, INC.

2nd Floor, United Life Building, A. Arnaiz,
Legaspi Village, Makati, Metro Manila, Philippines
Phone: (63-2) 812-4001 Fax: (63-2) 817-7576

FUJITSU SYSTEM INDONESIA

J1. Cideng Timur 55
Jakarta 10150, Republic of Indonesia
Phone: (62-21)344-1601 Fax: (62-21) 344-2593

FUJITSU LIMITED (JAPAN)

Computer Products Business Group
4-1-1, Kamikodanaka, Nakahara-ku, Kawasaki-shi,
Kanagawa-ken 211-8588, Japan
Phone: (81-44) 754-8347 Fax: (81-44) 754-8348
HOME PAGE: <http://www.fujitsu.co.jp/hypertext/scanner/eng/>

IMPORTANT NOTE TO USERS

READ THIS ENTIRE MANUAL BEFORE USING THIS PRODUCT.
UNEXPECTED DAMAGE MAY OCCUR IF NOT USED CORRECTLY.

While all efforts have been made to ensure the accuracy of all information in this manual, FUJITSU assumes no liability to any party for any damage caused by errors or omissions or by statements of any kind in this manual, its updates or supplements, whether such errors are omissions or statements resulting from negligence, accidents, or any other cause. FUJITSU further assumes no liability arising from the application or use of any product or system described herein; nor any liability for incidental or consequential damages arising from the use of this manual. FUJITSU disclaims all warranties regarding the information contained herein, whether expressed, implied, or statutory.

FUJITSU reserves the right to make changes to any products herein, to improve reliability, function, or design, without further notice and without obligation.

Preface

This manual explains how to use the M4099D image scanner.

This manual contains basic instructions for scanner operation, cleaning parts replacement, adjustment and troubleshooting.

Refer to Operator's Guide for the basic information about the M4099D.

The M4099D is very fast and highly functional image scanner developed for volume filing, using charge-coupled device (CCD) image sensors. This scanner features duplex scanning and high quality image, processing with an automatic document feeder (ADF).

Conventions

Special information, such as warnings, cautions are indicated as follows:

WARNING

WARNING indicates that personal injury may result if you do not follow procedure correctly.

CAUTION

CAUTION indicates that damage to the scanner may result if you do not follow a procedure correctly.

The following symbols are used in this manual.



Used for general WARNING and CAUTION.



Indicates that care must be taken to avoid injury to hands or fingers.

CONTENTS

CHAPTER 1 OPERATING INSTRUCTIONS	1-1
Units and Assemblies	1-2
Loading Documents	1-5
Inserting Documents Manually	1-7
Upper Transport Unit	1-8
CHAPTER 2 CLEANING	2-1
Cleaning Tools and Roller Position	2-2
Rollers	2-3
Transport Path, Discharge Brush, and Glass Surface	2-6
Sensors	2-12
Front-Side Lamp	2-14
Back-Side Lamp	2-16
CHAPTER 3 REPLACEMENT OF PARTS	3-1
Front-Side Lamp	3-2
Back-Side Lamp	3-4
Pick Roller Unit	3-6
Brake Roller	3-8
Pad	3-11
CHAPTER 4 ADJUSTMENT	4-1
Improving Paper Separation	4-2
CHAPTER 5 TROUBLESHOOTING	5-1
Paper Jam	5-2
Initial Checks	5-5
Messages and Actions	5-13
Problem Checklist	5-15
Appendix	5-16

CHAPTER 1 OPERATING INSTRUCTIONS

OPERATING
INSTRUCTIONS

CHAPTER 2 CLEANING

CLEANING

CHAPTER 3 REPLACEMENT OF PARTS

REPLACEMENT
OF PARTS

CHAPTER 4 ADJUSTMENT

ADJUSTMENT

CHAPTER 5 TROUBLESHOOTING

TROUBLESHOOTING

OPERATING INSTRUCTIONS

This chapter describes how to load documents, how to insert documents manually and how to open/close the upper transport unit.

Units and Assemblies

Loading Documents

Inserting Documents Manually

Upper Transport Unit

Units and Assemblies

This section shows the exterior view and assemblies of the scanner. This section also provides names of each part and describes their functions.

■ Units

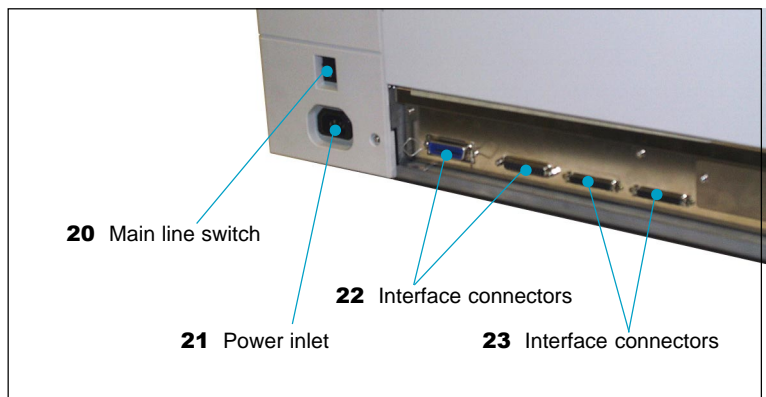
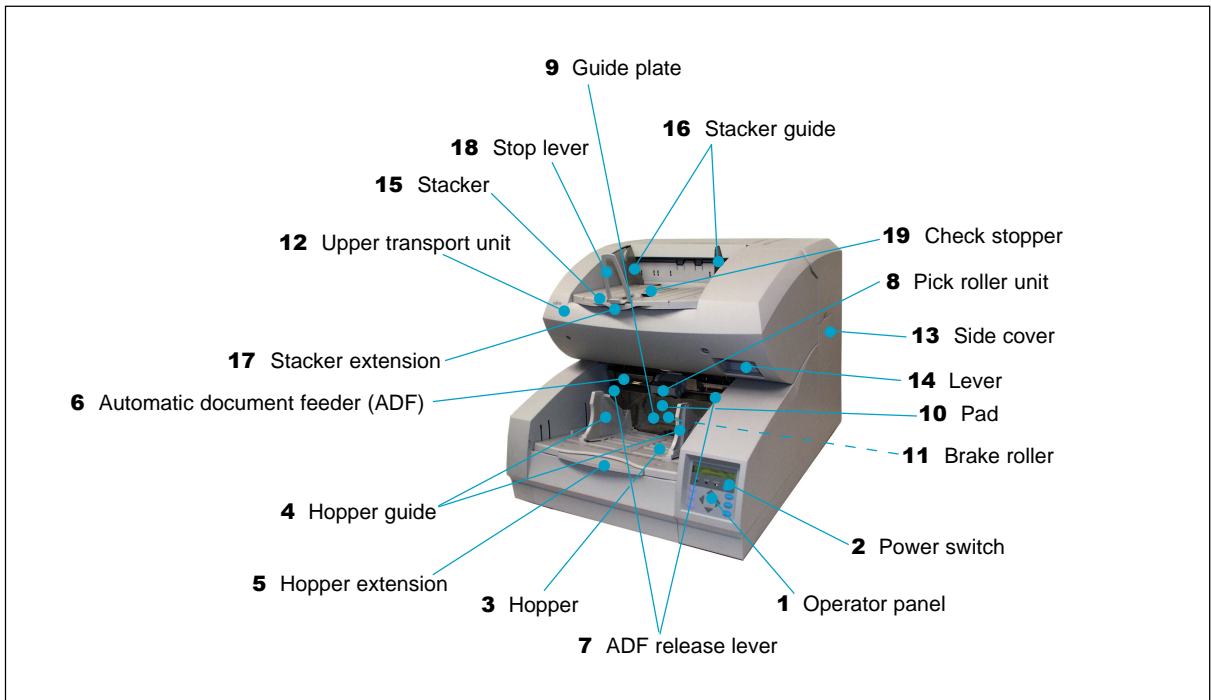

No.	Name	Function
1	Operator panel	Used to operate the scanner.
2	Power switch	Used to turn power on or off.
3	Hopper	Document input tray.
4	Hopper guide	Used to adjust the document width.
5	Hopper extension	For use with long documents.
6	Automatic document feeder (ADF)	Feeds and scans documents.
7	ADF release lever	Used to open the ADF.
8	Pick roller unit	Picks top page in document stack.
9	Guide plate	The pad is mounted on.
10	Pad	Separates top page from document stack.
11	Brake roller	Separates top page from document stack.
12	Upper transport unit	Opens for easy access.
13	Side cover	Opens to access back-side lamp.
14	Lever	Used to open the upper transport unit.
15	Stacker	Document exit tray.
16	Stacker guide	Helps guide documents into stacker.
17	Stacker extension	For use with long documents.
18	Stop lever	Used to keep documents in the stacker.
19	Check stopper	Adjustable stopper for shorter length documents.
20	Main line switch	Controls supply of line power to the scanner.
21	Power inlet	Power cable connection.
22	Interface connectors	Video and RS-232C.
23	Interface connectors	Two SCSIs.

■ Assemblies

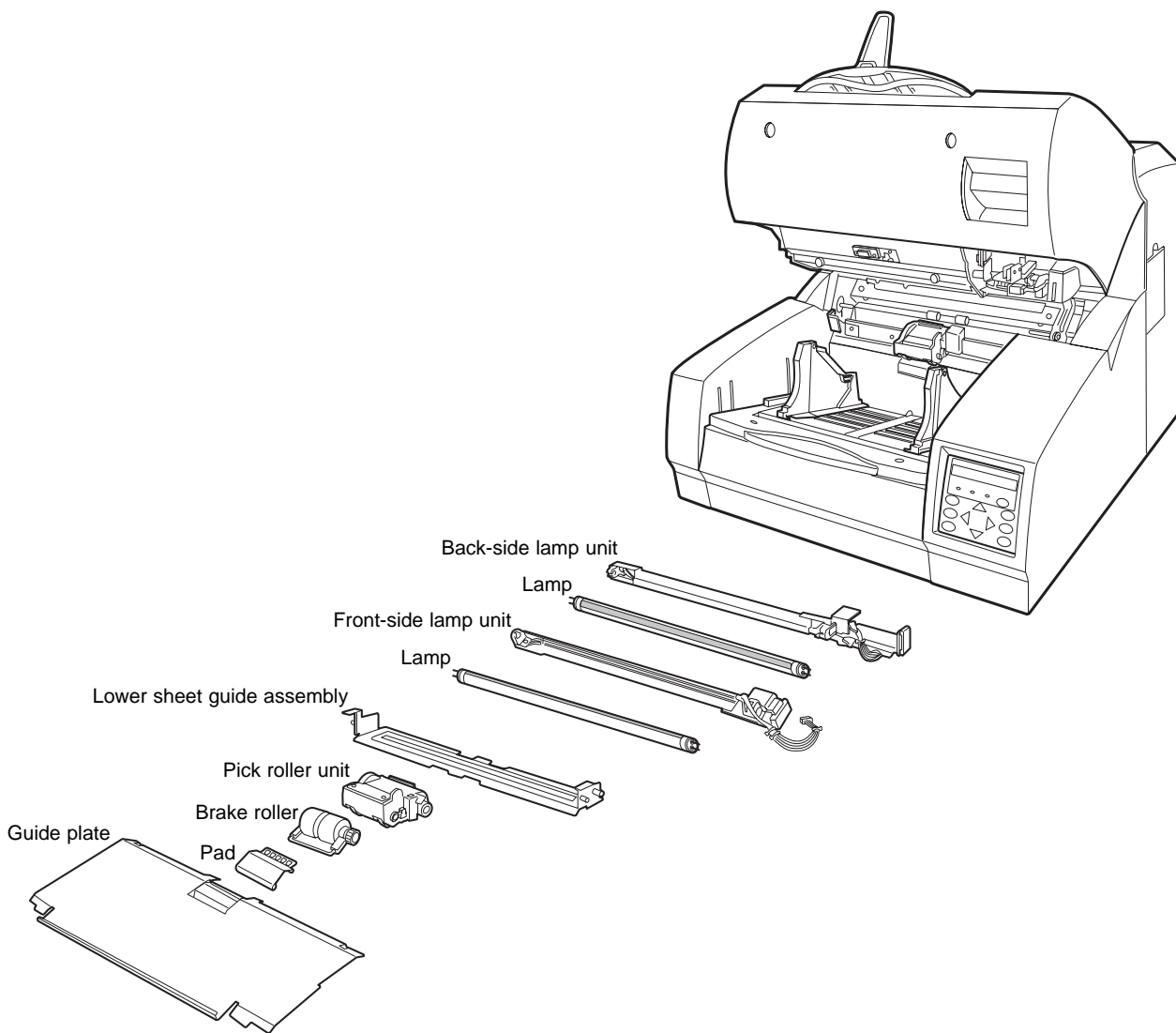

Loading Documents

Load the document for reading.

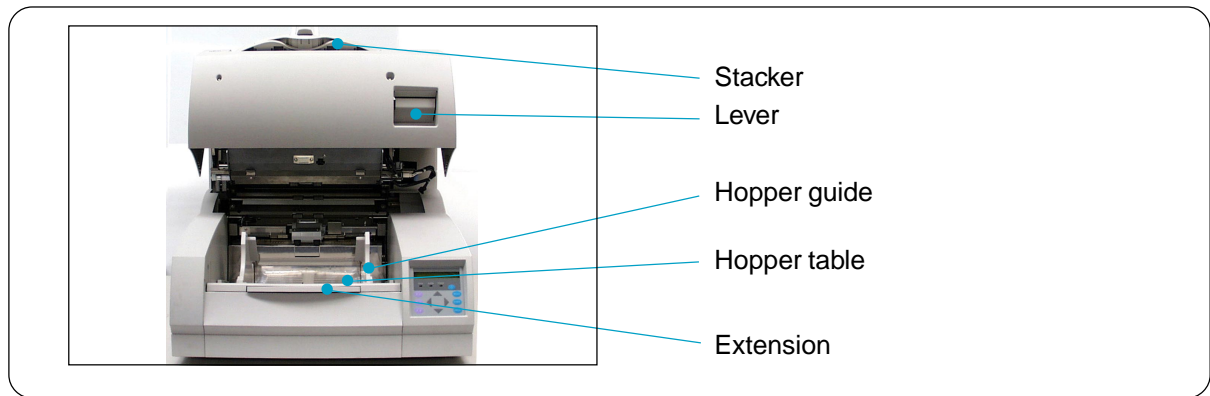

1 Fan the sheets before setting the document on the hopper table.

NOTE

Hold both ends and bend the documents into an arch. Then hold tightly and straighten them. The center of documents swells and air is introduced between the documents.

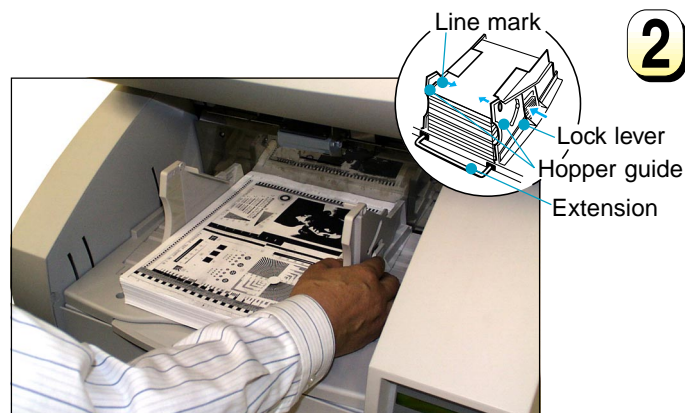
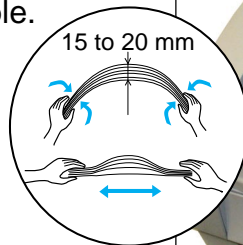

2 Adjust the hopper guides to the document width. And load documents face-up.

NOTE

- Squeeze the lock lever to free the Hopper guides.
- Remove paper clips and staples. Flatten staple holes with your finger.
- Load documents face-up.
- Stack must not exceed line mark.
- Use the extension for long documents.
- Do not mix different width documents.

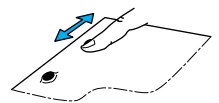

3 Adjust the stacker table to the document size.

 **NOTE**

- Extend the stacker table and extension for long documents (greater than A4 or LT).
- Raise the stopper for small sizes of paper and adjust the stacker guides to the width of the paper and push down the stacker table to lock it.

Stopper adjustment:

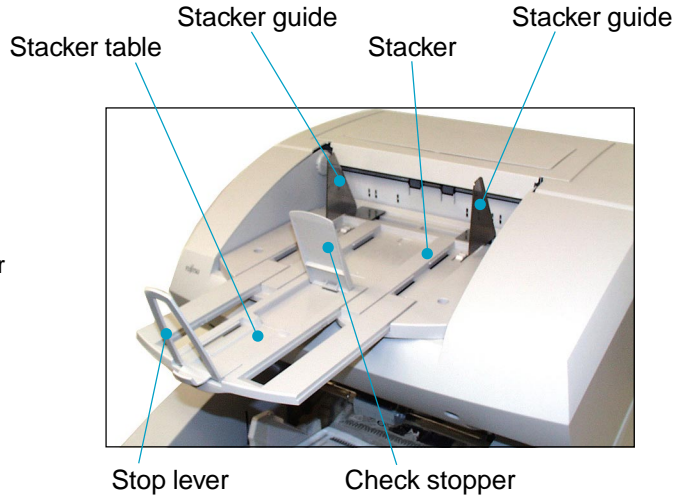
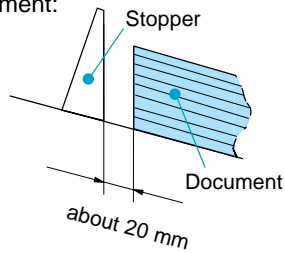

4 Scanned documents are stacked in the stacker for removal.

Inserting Documents Manually

If the scanner is in Manual Mode, set the documents as follows:

- 1** Lift the pick roller unit until it is held by the magnet catch. The hopper table moves up to the feed position.

 **CAUTION**

Be careful not to catch your fingers or something in the mechanism, when the hopper table moves up.



Hopper guide Document (face-up) Guide plate Hopper table



- 2** Place documents face-up at the center of the hopper table.

 **NOTE**

For information on setting Manual feed timeout, see the Operating Instructions in the Operator's Guide.

- 3** Insert the documents until the leading edge touches the guide plate of the hopper table. Adjust the guides to the document width.

Upper Transport Unit

WARNING

Before lowering down the unit, make sure that the area between the main machine and the upper transport unit is clear of all objects and fingers.

ACHTUNG

Bevor Sie die obere Einheit absenken, überzeugen Sie sich, daß keine Gegenstände oder Finger eingeklemmt werden.

■ Opening the Upper Transport Unit

- 1** Lift the lever located at the right to open the upper transport unit.

CAUTION

Make sure that the upper transport unit is in the locked position before reaching inside the scanner.

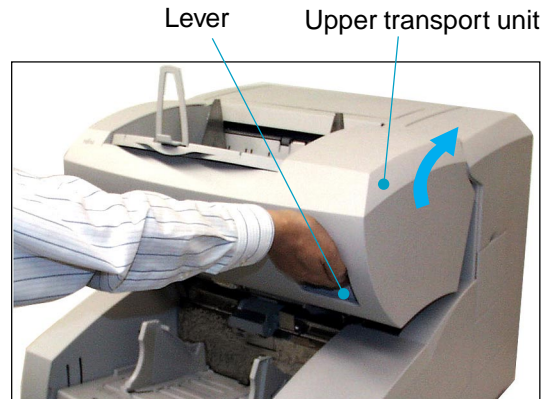

■ Closing the Upper Transport Unit

- 1** Lift the upper transport unit to release the lock.



- 2** Lower the upper transport unit with both hands.

NOTE

Press the upper transport unit with both hands to secure the lock.



CLEANING

This chapter describes the tools and methods required to keep your scanner clean.

Cleaning Tools and Roller Position

Rollers

Transport Path, Discharge Brush, and Glass Surface



Sensors

Front-Side Lamp

Back-side Lamp

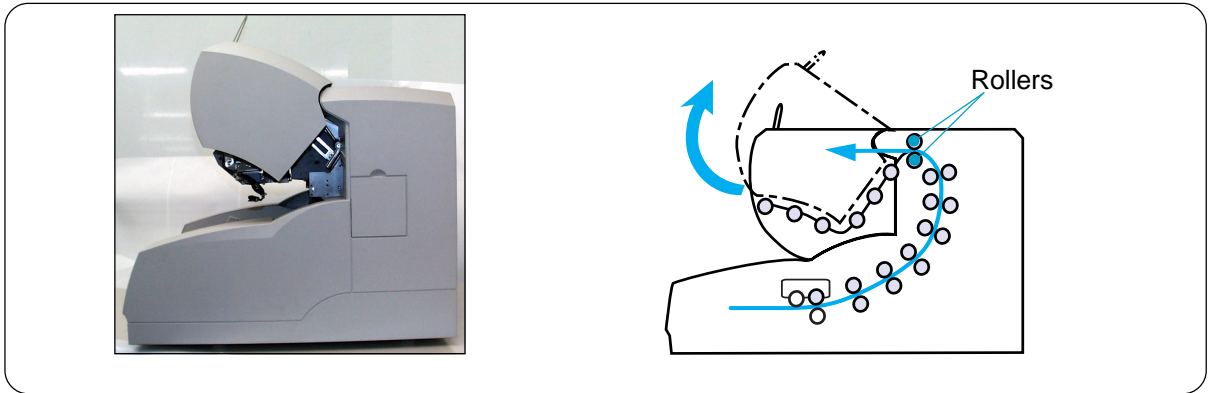
Cleaning Tools and Roller Position

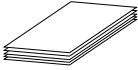

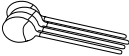
Tools	Type No.	Frequencies	Remarks
Cleaning sheet 	CA99501-0016 (*)	Every 50,000 sheets	20 sheets/1 pack
Cleaner F2 	CA99501-0014 (*)	<ul style="list-style-type: none"> • Front-side and back-side lamp Every 100,000 sheets • Roller Every 100,000 sheets 	1 bottle
Isopropyl alcohol or Cleaner F1 	CA99501-0013 (*)	<ul style="list-style-type: none"> • Discharge brush Every 100,000 sheets • Others Every 200,000 sheets 	1 bottle
Cotton swabs 			
Dry cloth			

*: Contact dealer or distributor. Type No. may be different in some countries.

NOTE

When the following paper is used, it may be necessary to clean more frequently.

- Paper with smooth surface such as coated paper.
- Paper with almost all printed area.
- Paper with special coating such as carbonless paper.

Rollers

■ Cleaning the Rollers with Cleaning Sheets

- 1 Set the hopper table guides to B4 width. Then, set the offline feed test mode as follows:

While pressing **MENU**, turn on the power; the LCD displays "Please wait" then the <<MODE SELECT>> screen appears with SETUP blinking. Press **▶** (→) twice; TEST blinks. Press **ENTER** three times; The OFFLINE FEED TEST screen appears with START blinking.

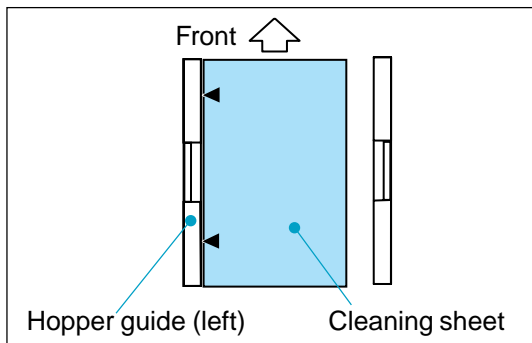

- 2 Remove the protective paper from the cleaning sheet.

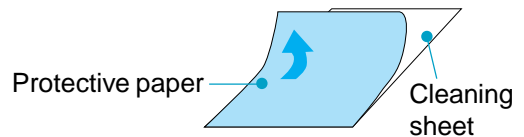

- 3 Place the cleaning sheet on the hopper table by aligning it with the hopper guide (left) with the adhesive side up. Then press **ENTER**; the cleaning sheet is fed.

- 4 When “Hopper empty” is displayed, press **CANCEL** .
- 5 Place the same cleaning sheet on the hopper table with the adhesive side up by aligning with the hopper guide (right). Then press **ENTER** ; the cleaning sheet is fed.
- 6 When “Hopper empty” is displayed, press **CANCEL** .

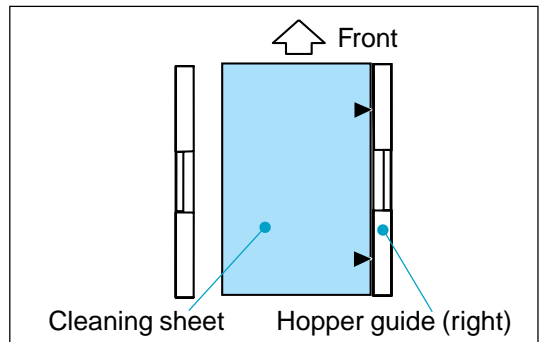

-
- 7 Remove the protective paper from a new cleaning sheet and place it with the adhesive side face down. Then repeat steps 3 through 6. After cleaning is complete, turn the power off.

⚠ WARNING

Wait at least 3 minutes after turning off the power before cleaning.

⚠ ACHTUNG

Warten Sie nach dem Reinigen mindestens 3 Minuten bevor Sie den Scanner wieder anschalten.

■ Cleaning the Rollers with Dry Cloth, Isopropyl Alcohol or Cleaner F1

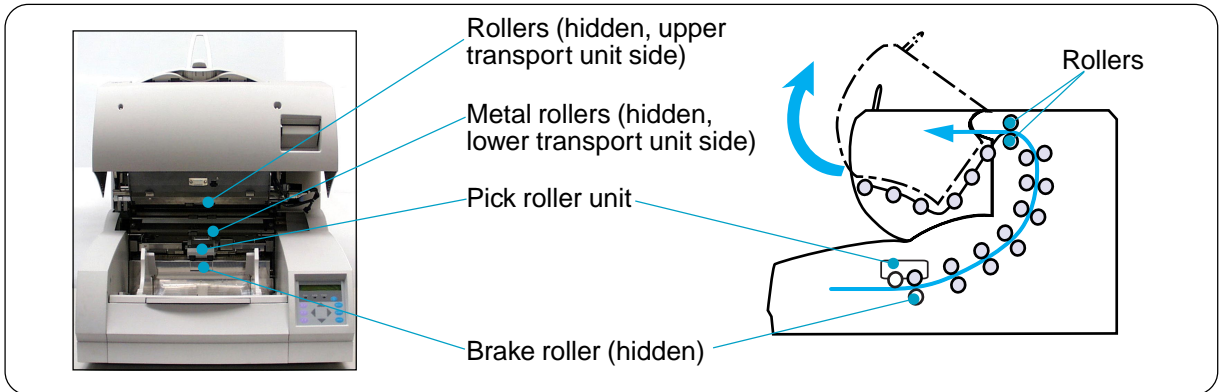

1 Open the upper transport unit.

2 Apply isopropyl alcohol or cleaner F1 to cloth.

3 Wipe the pick roller unit, brake roller and the upper and lower transport unit rollers.

4 Allow to dry.

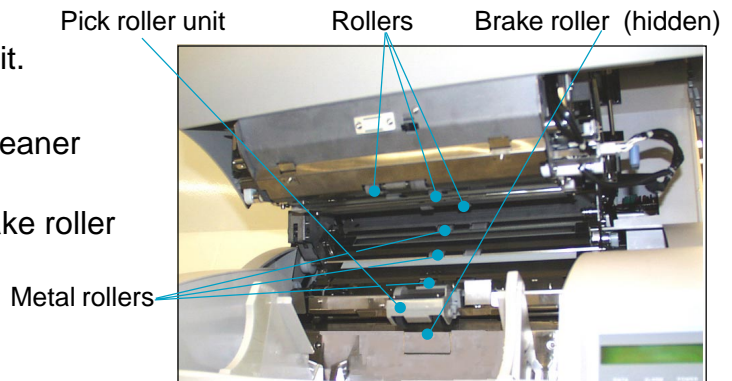

■ Cleaning the Metal Rollers with Cleaner F2

⚠ WARNING

Do not use cleaner F2 on rubber rollers.

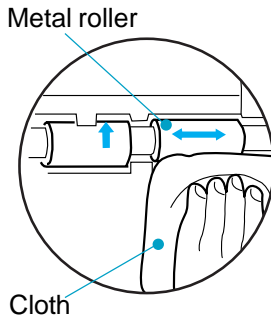

1 Open the upper transport unit.

2 Moisten a cloth with cleaner F2.

3 Wipe the metal roller surfaces (lower transport unit side) while turning the shaft by hand.

4 Allow to dry.

Transport Path, Discharge Brush, and Glass Surface

⚠ WARNING

Wait at least 3 minutes after turning off the power before cleaning.

⚠ ACHTUNG

Warten Sie nach dem Reinigen mindestens 3 Minuten bevor Sie den Scanner wieder anschalten.

■ Cleaning the Transport Path

- 1 Open the upper transport unit.
- 2 Wipe the transport path with a dry cloth or soaked in isopropyl alcohol or cleaner F1.

NOTE

Use a vacuum cleaner to remove paper dust from the transport path.



■ Cleaning the Discharge Brush

- 1 Open the upper transport unit.
- 2 While pulling the ADF release lever toward you, hold up the ADF sheet guide assembly.



ADF release levers

- 3 Release the ADF release lever and rest the ADF sheet guide assembly on the ADF release lever.

⚠ CAUTION

Never close the upper transport unit in this condition. Doing so will cause severe damage to the scanner.



Pick roller unit

- 4** Slide the pick roller unit left and remove it toward the upper right.

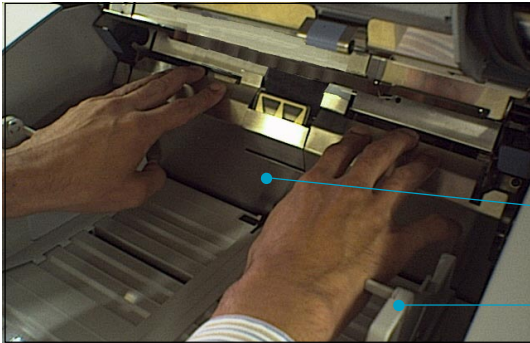
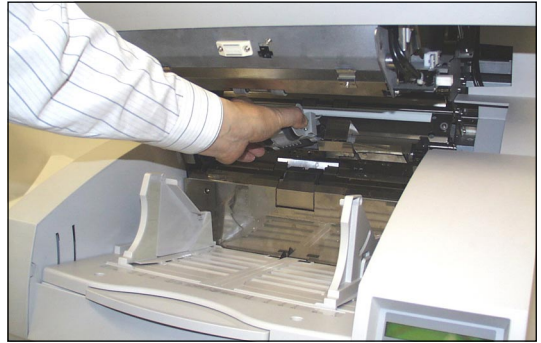

- 5** Holding the top of the guide plate, press the guide plate down, and lift it toward you to remove it.

Guide plate

Hopper guide

- 6** Turn the lever of the brake roller upward and pull out the brake roller upward.

Brake roller

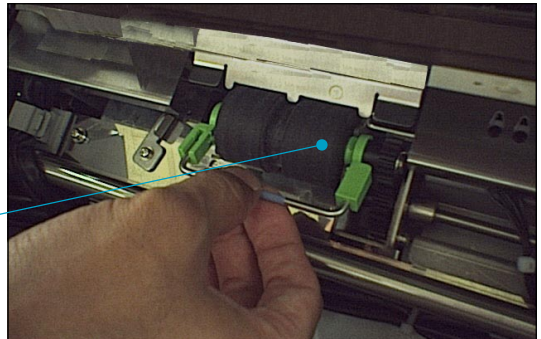

- 7** Wipe the discharge brush with a dry cloth to remove dust.

Discharge brush (for pick roller unit)

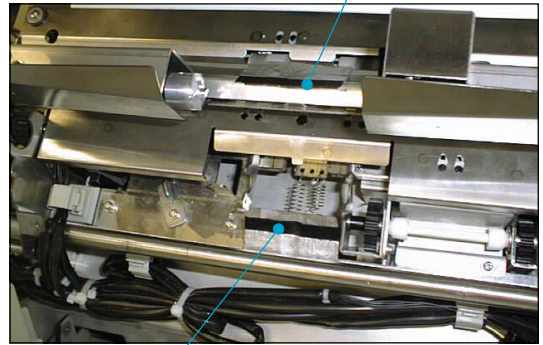

Discharge brush (for brake roller)

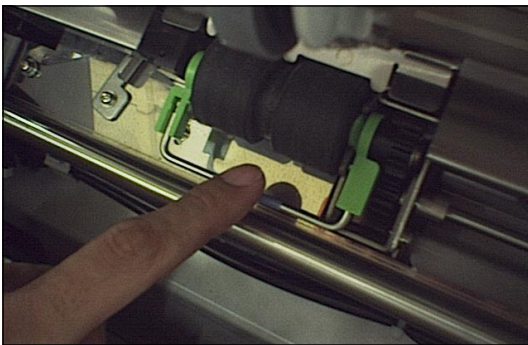

- 8** Attach the brake roller until it locks.

- 9** Put the guide plate in position.

 **NOTE**

Confirm that the guide plate is installed correctly. If it is miss connected, it will cause paper jams and noise by touching the hopper table.

- 10** Attach the pick roller unit as shown.

CAUTION

When attaching the pick roller unit, do not hang down its head.

- 11** While holding the ADF sheet guide assembly up, pull the ADF release lever toward you then gently lower the ADF sheet guide assembly. Release the ADF release lever to lock the ADF sheet guide assembly into position.

CAUTION

Hold the ADF sheet guide assembly during this process to avoid damage to the sensors.

- 12** Close the upper transport unit.

Right

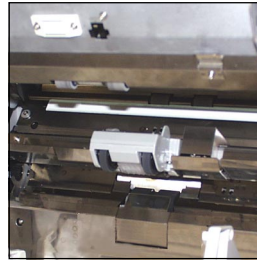

Wrong

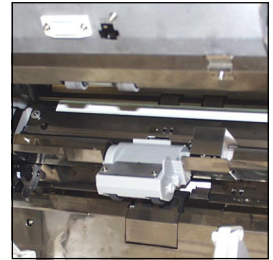

ADF release levers

⚠ WARNING

Wait at least 3 minutes after turning off the power before cleaning.

⚠ ACHTUNG

Warten Sie nach dem Reinigen mindestens 3 Minuten bevor Sie den Scanner wieder anschalten.

■ Cleaning the Glass Surface (Upper sheet guide assembly)

- 1** Open the upper transport unit.
- 2** Loosen the two knurled screws at both ends of the upper sheet guide assembly to open the assembly.

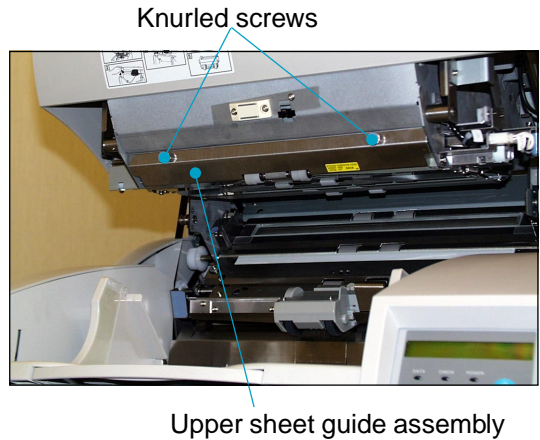

- 3** Wipe both surfaces of the glass clean with a dry cloth (or moistened with isopropyl alcohol or cleaner F1 as necessary).
- 4** Close the upper sheet guide assembly and tighten the two knurled screws.
- 5** Close the upper transport unit.

⚠ WARNING

Wait at least 3 minutes after turning off the power before cleaning.

⚠ ACHTUNG

Warten Sie nach dem Reinigen mindestens 3 Minuten bevor Sie den Scanner wieder anschalten.

■ Cleaning the Glass Surface (Lower sheet guide assembly)

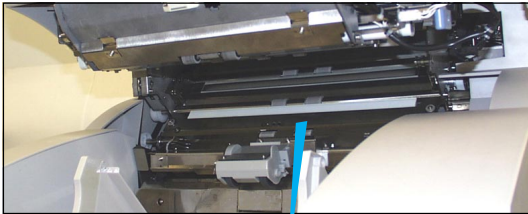

1 Open the upper transport unit.

2 Pull down on the lower sheet guide assembly tabs to remove it.

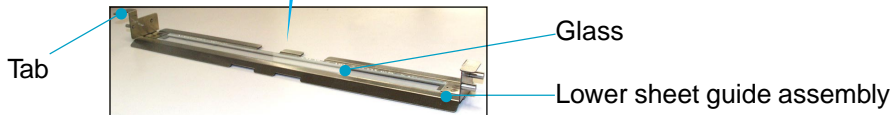

3 Wipe the glass clean with a dry cloth (or moistened with isopropyl alcohol or cleaner F1 as necessary).

4 Align the lower sheet guide assembly in the guide rails and push it back into place.

5 Close the upper transport unit.

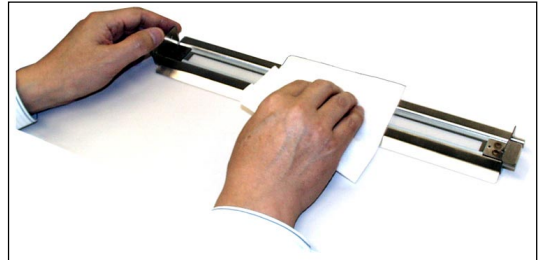

Sensors

WARNING

Wait at least 3 minutes after turning off the power before cleaning.

ACHTUNG

Warten Sie nach dem Reinigen mindestens 3 Minuten bevor Sie den Scanner wieder anschalten.

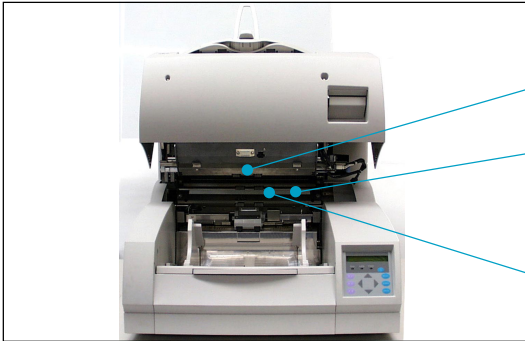

SF2 sensor (inside)

ADF sheet guide assembly

Document width detection sensors (inside)

■ Document Width Detection Sensors (Eight positions for upper and lower sides respectively)

- 1** Open the upper transport unit.
- 2** Open and hold the ADF sheet guide assembly.

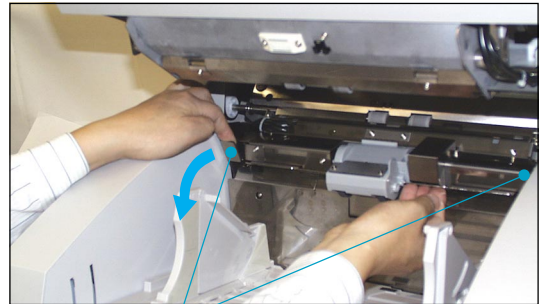

ADF release levers

Document width detection sensors (upper)

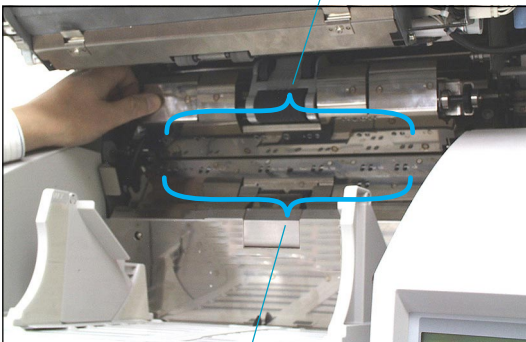

Document width detection sensors (lower)

- 3** Wipe the eight sensor surfaces with a dry cloth (or moistened with isopropyl alcohol or cleaner F1 as necessary).
- 4** Close the ADF sheet guide assembly.
- 5** Close the upper transport unit.

⚠ WARNING

Wait at least 3 minutes after turning off the power before cleaning.

⚠ ACHTUNG

Warten Sie nach dem Reinigen mindestens 3 Minuten bevor Sie den Scanner wieder anschalten.

■ SF2 Sensors

- 1 Open the upper transport unit.
- 2 Wipe the SF2 sensors in the transport path with a dry cloth (or moistened with isopropyl alcohol as necessary).
- 3 Close the upper transport unit.

SF2 sensors
(located at upper and lower sides)

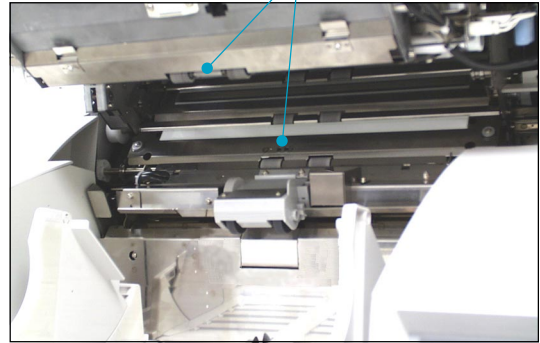

■ SF3 Sensors

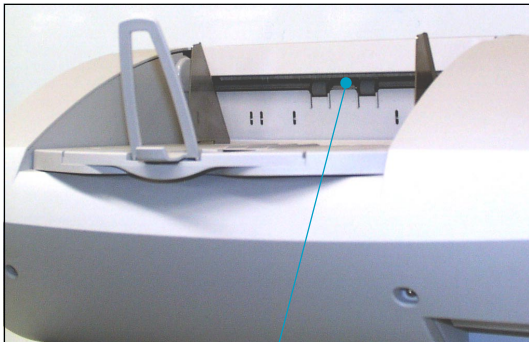

SF3 sensors
(located at upper and lower sides)

- 1 Open the upper transport unit.
- 2 Wipe the SF3 sensors surface with a dry cloth or a cotton swab (or moistened with isopropyl alcohol as necessary).
- 3 Close the upper transport unit.

Front-Side Lamp

⚠ WARNING

Wait at least 3 minutes after turning off the power before cleaning.

⚠ ACHTUNG

Warten Sie nach dem Reinigen mindestens 3 Minuten bevor Sie den Scanner wieder anschalten.

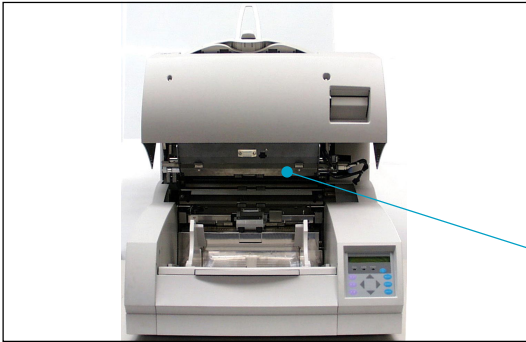

Front-side Lamp unit (inside)

- 1** Open the upper transport unit.
- 2** Remove the connector of the front-side lamp unit.
- 3** Pull out the front-side lamp unit toward the right.

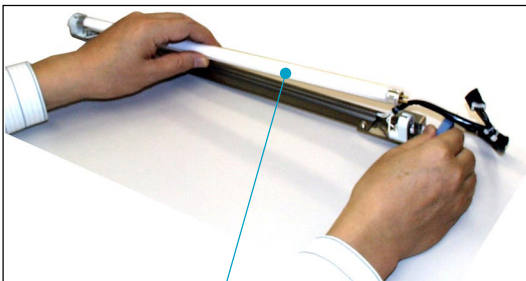

Lamp

- 4** Rotate the lamp a half turn so that the two terminals on each end align with the slot on the lamp socket and remove the lamp from the front-side lamp unit.

- 5** Clean the clear portion of the lamp with a dry cloth.

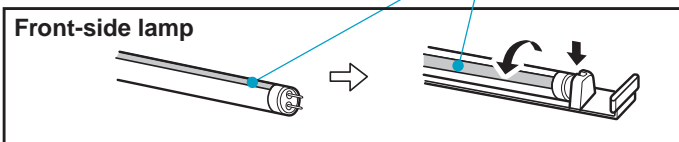
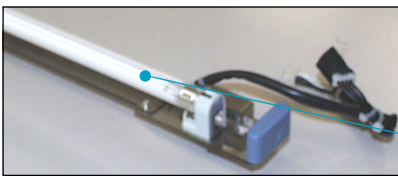
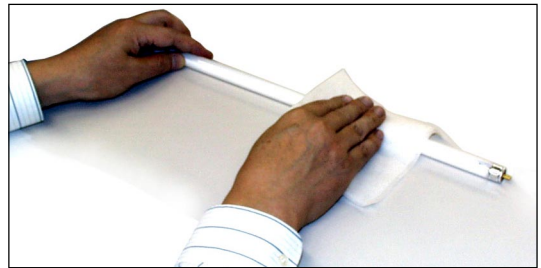

- 6** Install the lamp in the front-side lamp unit. Insert the terminals of the lamp into the socket and rotate the lamp. Be sure that the clear portion is positioned as shown left, otherwise black stripes may appear in the scanned image.

- 7** Put the front-side lamp unit into the upper transport unit using the two guide grooves and rails until it locks.

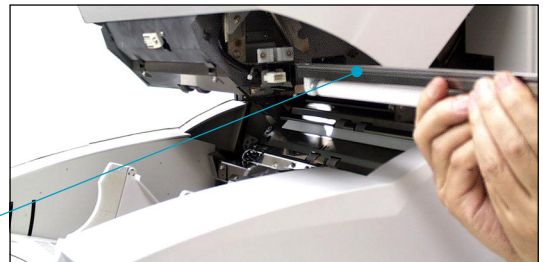

Rail

- 8** Connect the lamp connector.

- 9** Close the upper transport unit.

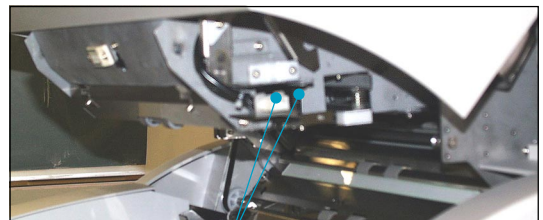

Guide grooves (one hidden)

Back-Side Lamp

⚠ WARNING

Wait at least 3 minutes after turning off the power before cleaning.

⚠ ACHTUNG

Warten Sie nach dem Reinigen mindestens 3 Minuten bevor Sie den Scanner wieder anschalten.



Side cover

Back-side lamp unit (inside)

- 1** Pull and open the side cover.
- 2** Remove the connector of the back-side lamp unit.
- 3** Pull out the back-side lamp unit toward the right.

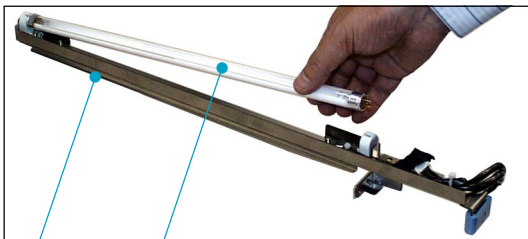

Rail

Lamp

- 4** Rotate the lamp a half turn so that the two terminals on each end align with the slot on the lamp socket and remove the lamp from the back-side lamp unit.

- 5** Clean the clear portion of the lamp with a dry cloth.

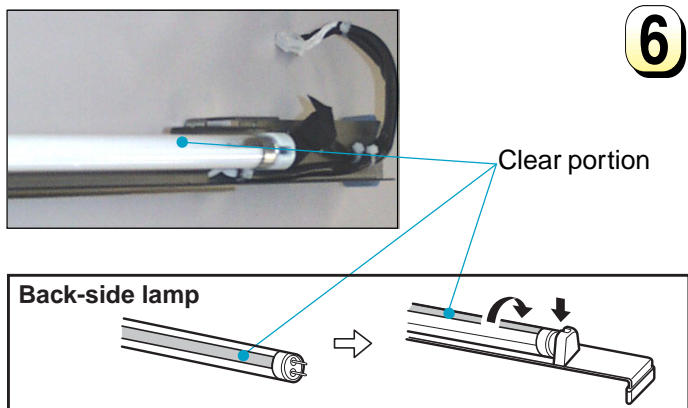
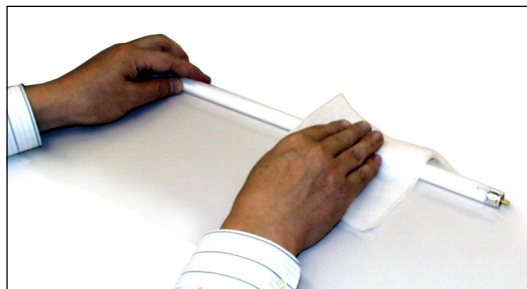

- 6** Install the lamp in the back-side lamp unit. Insert the terminals of the lamp into the socket and rotate the lamp. Be sure that the clear portion is positioned as shown left, otherwise black stripes may appear in the scanned image.

- 7** Re-install the lamp unit using the two guide grooves and rails.
- 8** Connect the connector of the back-side lamp unit.
- 9** Close the side cover securely, otherwise the cover open error may occur.

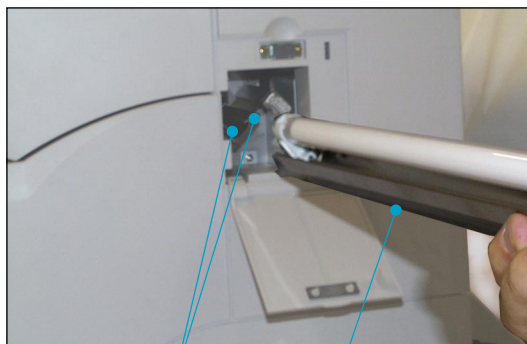

Guide grooves (one hidden) Rail

REPLACEMENT OF PARTS

This chapter describes how to replace parts of the scanner.

Front-Side Lamp

Back-Side Lamp

Pick Roller Unit

Brake Roller

Pad

Front-Side Lamp

WARNING

Never replace the lamp without turning off the power.
Wait at least 3 minutes after turning off the power before touching the lamp.

ACHTUNG

Wechseln Sie niemals die Lampe ohne den Scanner auszuschalten.
Warten Sie mindestens 3 Minuten nach Ausschalten, bevor Sie die Lampe anfassen.

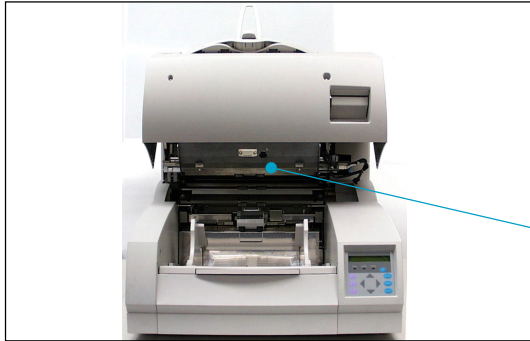

Front-side lamp unit (inside)

- 1** Open the upper transport unit.
- 2** Remove the connector of the front-side lamp unit.
- 3** Pull out the front-side lamp unit toward the right.

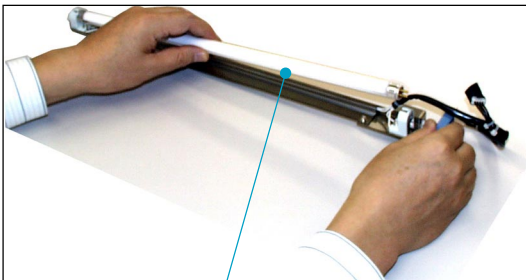

Lamp

- 4** Rotate the lamp a half turn so that the two terminals on each end align with the slot on the lamp socket and remove the lamp from the front-side lamp unit.

- 5** Install a new lamp in the front-side lamp unit. Insert the terminals of the lamp into the socket and rotate the lamp. Be sure that the clear portion is positioned as shown right, otherwise black stripes may appear in the scanned image.

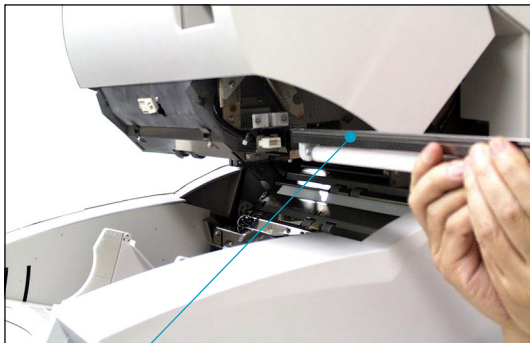
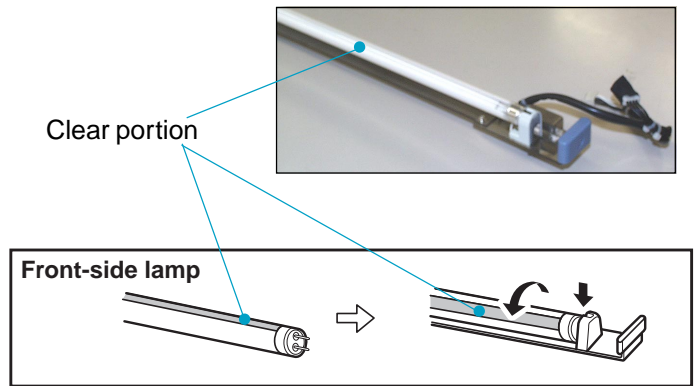

Rail Guide grooves (one hidden)

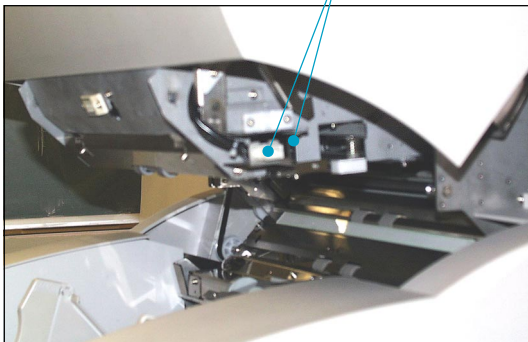

- 6** Put the front-side lamp unit into the upper transport unit using the two guide grooves and rails until it locks.
- 7** Connect the lamp connector.
- 8** Close the upper transport unit.

Back-Side Lamp

⚠ WARNING

Never replace the lamp without turning off the power.
Wait at least 3 minutes after turning off the power before touching the lamp.

⚠ ACHTUNG

Wechseln Sie niemals die Lampe ohne den Scanner auszuschalten.
Warten Sie mindestens 3 Minuten nach Ausschalten, bevor Sie die Lampe anfassen.



Side cover

Back-side lamp unit (inside)

- 1** Pull and open the side cover.
- 2** Remove the connector of the back-side lamp unit.
- 3** Pull out the back-side lamp unit toward the right.

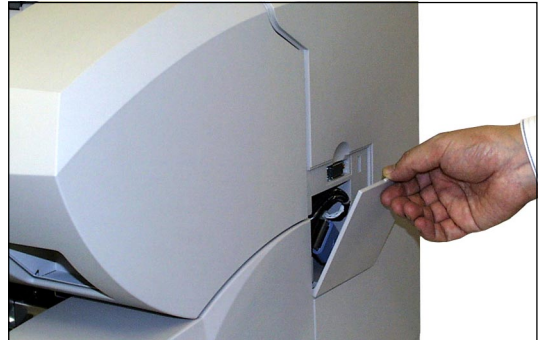

- 4** Rotate the lamp a half turn so that the two terminals on each end align with the slot on the lamp socket and remove the lamp from the back-side lamp unit.

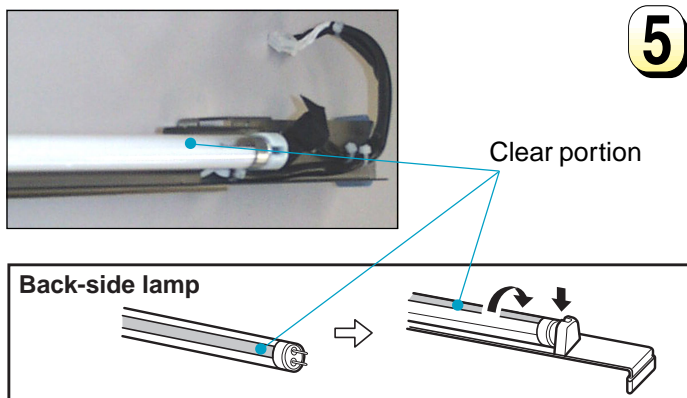
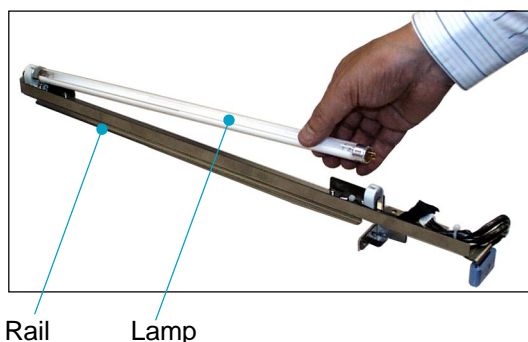

- 5** Install a new lamp in the back-side lamp unit. Insert the terminals of the lamp into the socket and rotate the lamp. Be sure that the clear portion is positioned as shown left, otherwise black stripes may appear in the scanned image.

- 6** Install the lamp unit using the two guide grooves and rails.
- 7** Connect the connector of the back-side lamp unit.
- 8** Close the side cover securely, otherwise the cover open error may occur.

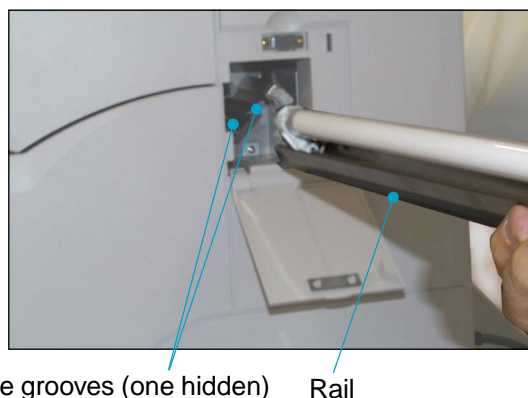

Pick Roller Unit

⚠ WARNING

Wait at least 3 minutes after turning off the power before replacement.

⚠ ACHTUNG

Warten Sie mindestens 3 Minuten nach Ausschalten, bevor Sie mit dem Austausch beginnen.

Set consumable counter when replacing the pick roller unit. (See Appendix)

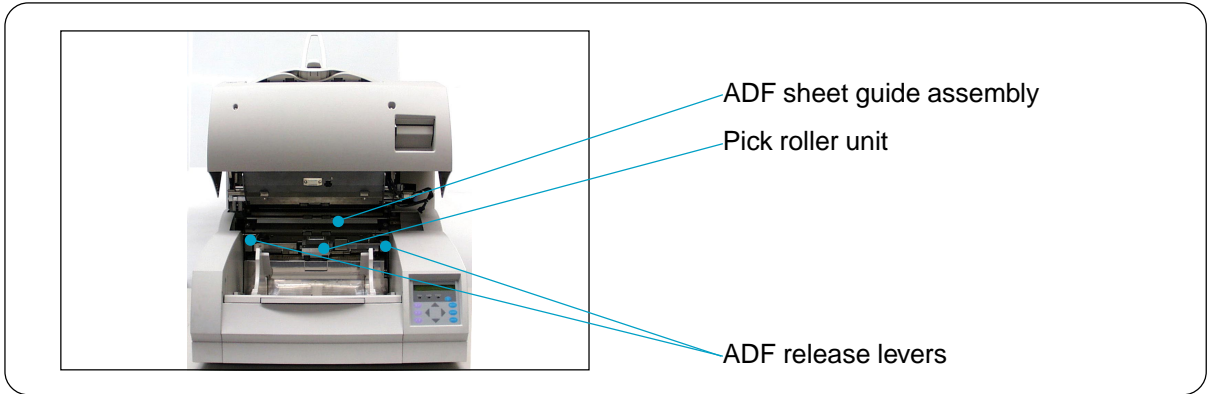

- 1 Open the upper transport unit.
- 2 While pulling the ADF release lever toward you, hold up the ADF sheet guide assembly.



- 3 Release the ADF release lever and rest the ADF sheet guide assembly on the ADF release lever.

⚠ CAUTION

Never close the upper transport unit in this condition. Doing so will cause severe damage to the scanner.



- 4** Slide the pick roller unit left and remove it toward the upper right.

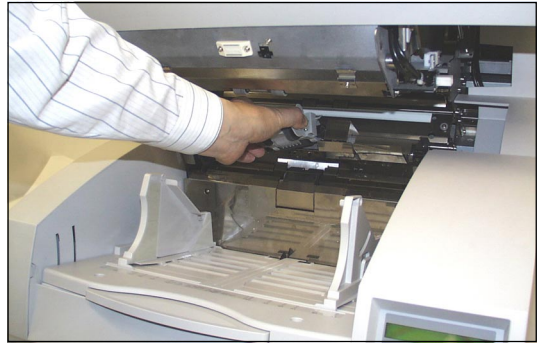

Right

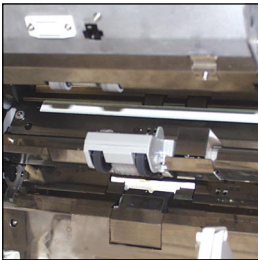

Wrong

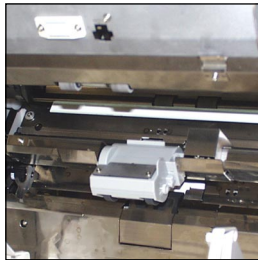

ADF release levers

- 5** Attach a new pick roller unit as shown.

CAUTION

When attaching a new pick roller unit, do not hang down its head.

- 6** While holding the ADF sheet guide assembly up, pull the ADF release lever toward you then gently lower the ADF sheet guide assembly. Release the ADF release lever to lock the ADF sheet guide assembly into position.

CAUTION

Hold the ADF sheet guide assembly during this process to avoid damage to the sensors.

- 7** Close the upper transport unit.

Brake Roller

⚠ WARNING

Wait at least 3 minutes after turning off the power before replacement.

⚠ ACHTUNG

Warten Sie mindestens 3 Minuten nach Ausschalten, bevor Sie mit dem Austausch beginnen.

Set abrasion counter when replacing the brake roller. (See Appendix)

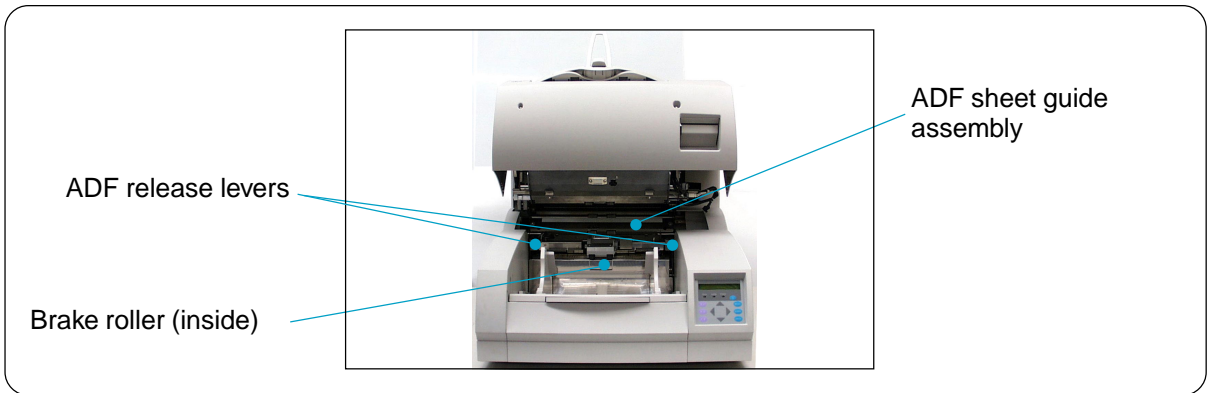

- 1 Open the upper transport unit.
- 2 While pulling the ADF release lever toward you, hold up the ADF sheet guide assembly.



- 3 Release the ADF release lever and rest the ADF sheet guide assembly on the ADF release lever.



⚠ CAUTION

Never close the upper transport unit in this condition, otherwise some component parts will be damaged.

- 4** Holding the top of the guide plate, press the guide plate down, and lift it toward you to remove it.

Hopper guide

Guide plate

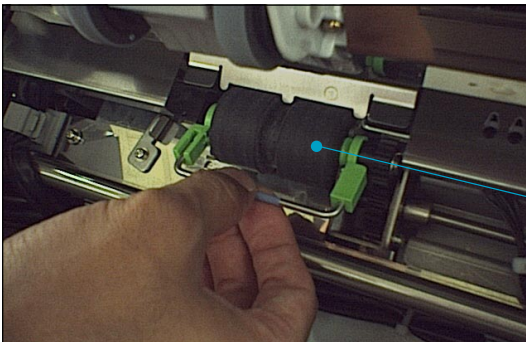
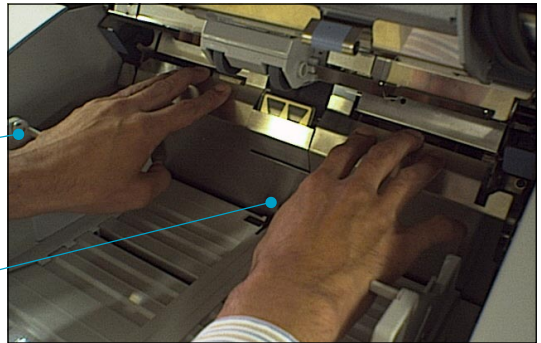

- 5** Turn the lever of the brake roller upward and pull out the brake roller upward.

Brake roller

- 6** Attach a new brake roller until it locks.

- 7** Put the guide plate in position.

 **NOTE**

Confirm that the guide plate is installed correctly. If it is miss connected, it will cause paper jams and noise by touching the hopper table.

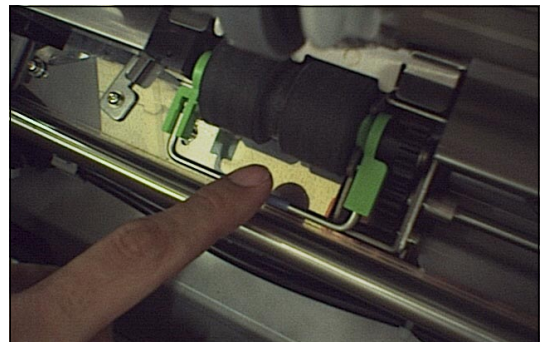

- 8** While holding the ADF sheet guide assembly up, pull the ADF release lever toward you then gently lower the ADF sheet guide assembly. Release the ADF release lever to lock the ADF sheet guide assembly into position.



CAUTION

Hold the ADF sheet guide assembly during this process to avoid damage to the sensors.

- 9** Close the upper transport unit.



ADF release levers

Pad

WARNING

Wait at least 3 minutes after turning off the power before replacement.

ACHTUNG

Warten Sie mindestens 3 Minuten nach Ausschalten, bevor Sie mit dem Austausch beginnen.

Set consumable counter when replacing the pad. (See Appendix)

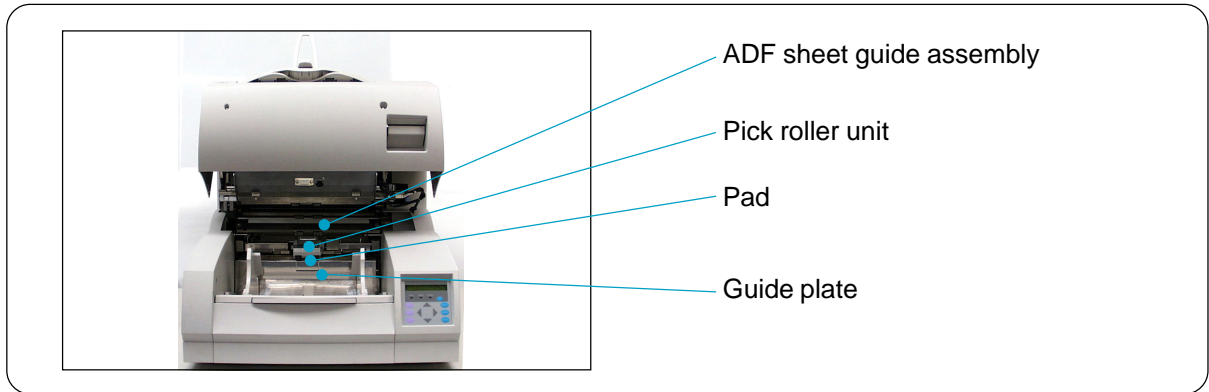

1 Open the upper transport unit.

2 While pulling the ADF release lever toward you, hold up the ADF sheet guide assembly.



ADF release levers

3 Release the ADF release lever and rest the ADF sheet guide assembly on the ADF release lever.



CAUTION

Never close the upper transport unit in this condition. Doing so will cause severe damage to the scanner.

- 4** Holding the top of the guide plate, press the guide plate down, and lift it toward you to remove it.

Hopper guide

Guide plate

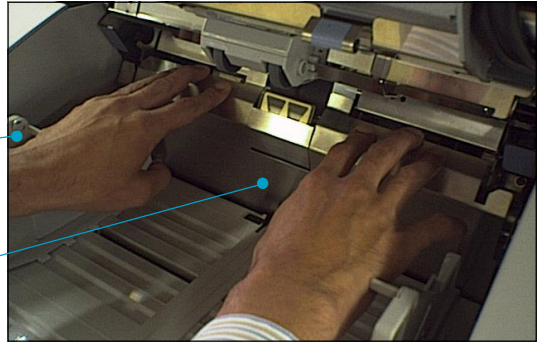

Rolled tab

Pad

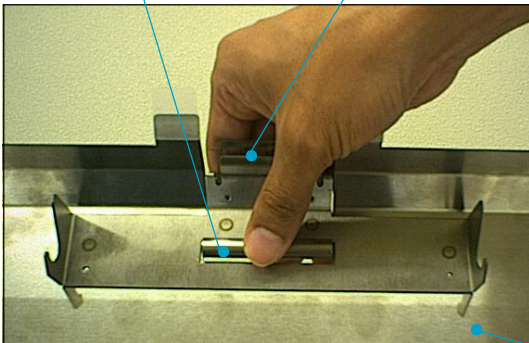

- 5** Press the rolled tab to remove the pad from the guide plate.

- 6** Attach a new pad to the guide plate.

Rolled tab

Pad

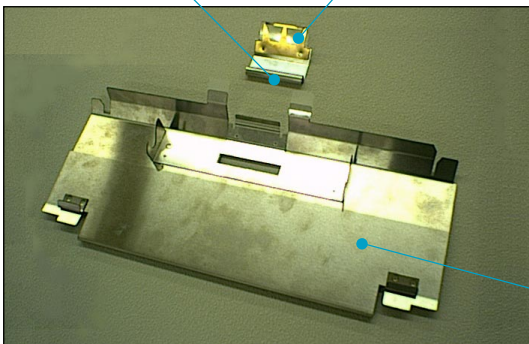

Guide plate

Guide plate

7 Put the guide plate in position.

8 While holding the ADF sheet guide assembly up, pull the ADF release lever toward you then gently lower the ADF sheet guide assembly. Release the ADF release lever to lock the ADF sheet guide assembly into position.



CAUTION

Hold the ADF sheet guide assembly during this process to avoid damage to the sensors.

9 Close the upper transport unit.



ADF release levers

ADJUSTMENT

This chapter describes the improving paper separation.

Improving Paper Separation



Improving Paper Separation

This section explains adjustment for making paper separation stable.

If the following errors frequently occur, make the adjustments explained below.

- Double feed
- Mis-pick
- SF2 did not detect leading edge of paper

1 Select “Paper Separation Level” in setup mode and adjust the braking power of the brake roller.

Setting	Braking power	“Double feed” frequently occurs.	“Mis-pick” or “SF2 ...” frequently occurs.
Thick	Strong	 Make the braking power stronger.	 Make the braking power weaker.
Medium Thick	Less strong		
Normal	Medium (factory default)		
Medium Thin	Less weak		
Thin	Weak		

2 Select “Picking Speed” in setup mode and adjust the rotational speed of the pick roller.

Picking speed	“Mis-pick” frequently occurs.
Fast (factory default)	 Make the picking speed slow.
Slow	

 **NOTE**

Processing of scanning in 200 dpi is reduced when the picking speed is set “Slow”.

TROUBLESHOOTING

This chapter describes the paper jam, initial checks, messages and actions, and problem checklist.

Paper Jam

Initial Checks

Messages and Actions

Problem Checklist

Appendix

Paper Jam

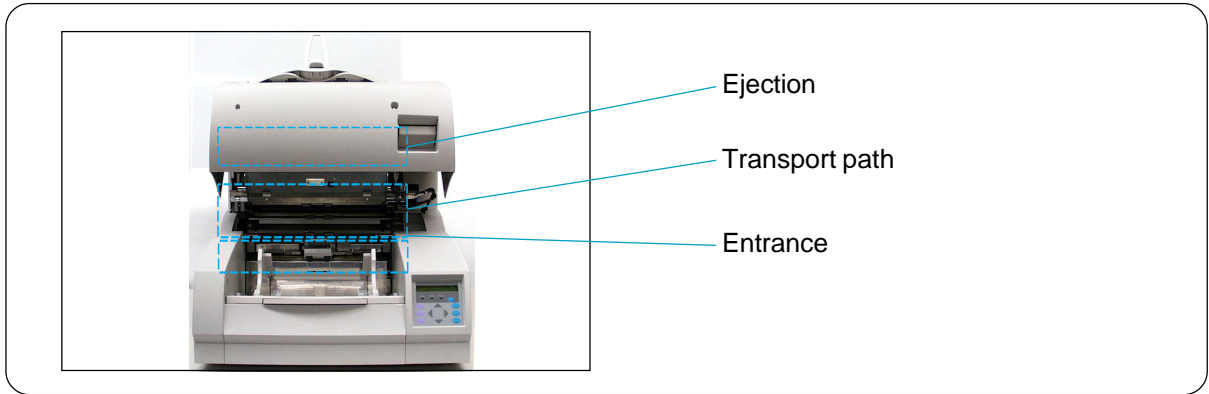

■ Jam at Entrance

- 1** Open the upper transport unit.
- 2** While pulling the ADF release lever toward you, hold up the ADF sheet guide assembly.
- 3** Release the ADF release lever and rest the ADF sheet guide assembly on the ADF release lever.

⚠ CAUTION

Never close the upper transport unit in this condition. Doing so will cause severe damage to the scanner.

ADF release levers

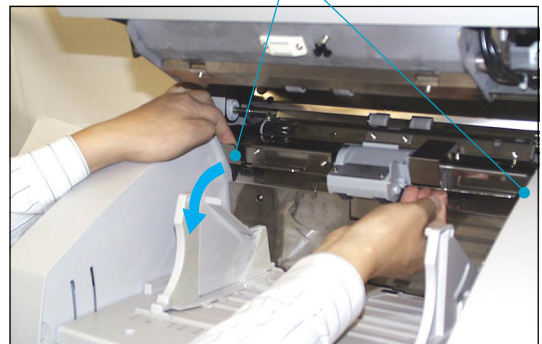

- 4** Remove the jammed paper.



Jammed paper



ADF release levers

- 5** While holding the ADF sheet guide assembly up, pull the ADF release lever toward you then gently lower the ADF sheet guide assembly. Release the ADF release lever to lock the ADF sheet guide assembly into position.

CAUTION

Hold the ADF sheet guide assembly during this process to avoid damage to the sensors.

- 6** Close the upper transport unit.

■ Jam at Transport Path

- 1 Open the upper transport unit.
- 2 Take out the jammed paper by opening the ADF sheet guide assembly.
- 3 Close the upper transport unit.



Jammed paper

■ Jam at Ejection

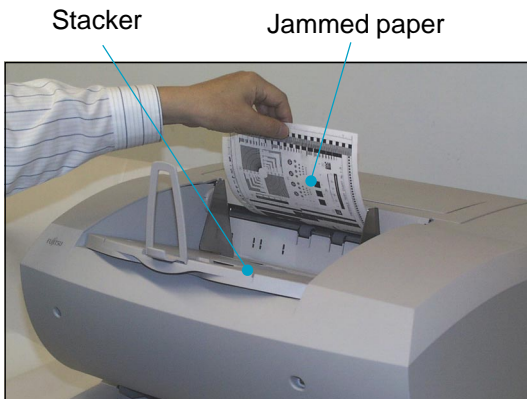

- 1 Open the upper transport unit.
- 2 Pull out the jammed paper to the stacker side.
- 3 Close the upper transport unit.

Initial Checks

If a problem occurs, check the following items before contacting a manufacturer's authorized service center.

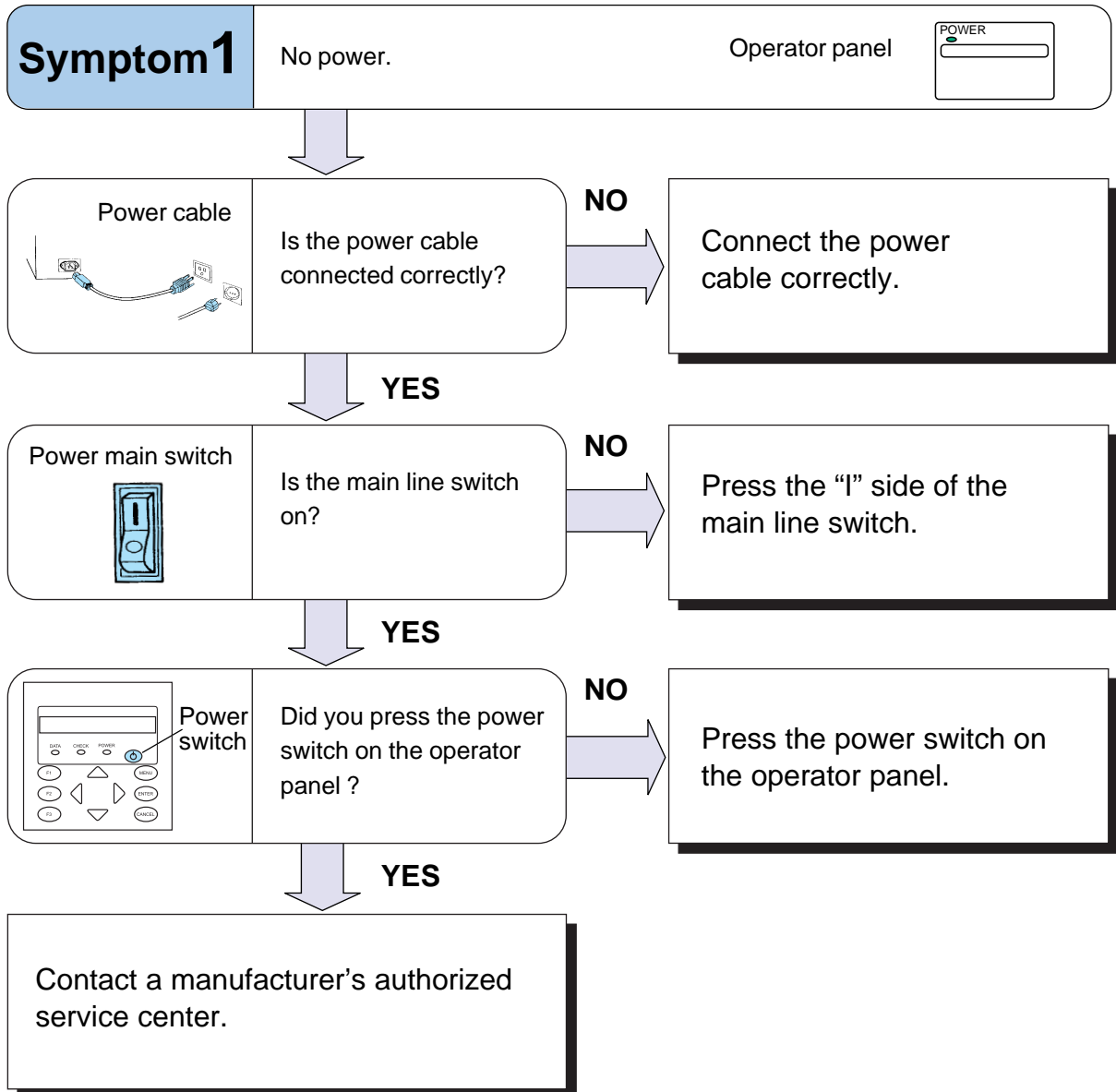

Symptom 2

Read processing does not start.

Operator panel

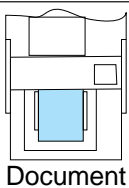
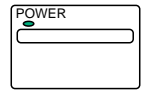

Document

Are the documents loaded properly? (Straight edge, no dogear, no bend corners, staples)

NO

Load the documents properly.
(See p1-5)

YES

Interface cable

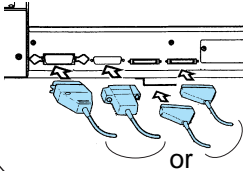

or

Is the interface cable connected properly?
Or is the baud rate correct?
(Video, RS-232C, or SCSI interfaces)

NO

Connect the interface cable properly.
Or set the correct baud rate.

YES

Operator panel

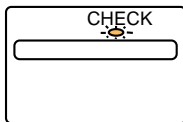

Does the CHECK lamp blink?

YES

Messages and Actions
(See p5-13)

NO

Turn the power off and on to check if read processing starts.
When read processing does not start, contact a manufacturer's authorized service center.

Symptom 3

Pictures and photographs are not read correctly.



Is "Photo" mode selected?

NO

Select the "Photo" mode (White level following off) through the scanner setting menu in the software.

YES

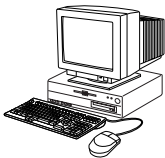

Is halftone or dithering processing selected?

NO

Select a halftone or dithering mode from the host computer.

YES

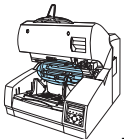

Transport path

Is there dirt or dust in transport path?

NO

Clean the rollers, transport path, glass and lamps. (See Chapter 2)

YES

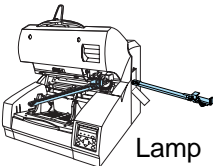

Lamp

Is the lamp attached correctly?

NO

Re-attach the lamp. (See p2-14 to 2-17, p3-2 to 3-5)

YES

Contact a manufacturer's authorized service center.

Symptom4

Characters and lines are not read correctly.



Is "Line Art" mode selected?

NO

Select "Line Art" mode from the host computer.

YES

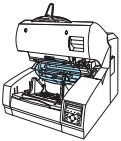

Transport path

Is there dirt or dust in transport path?

NO

Clean the rollers, transport path, glass, and lamps. (See Chapter 2)

YES

Contact a manufacturer's authorized service center.

Symptom 5

Black stripes appear in the image of the display.

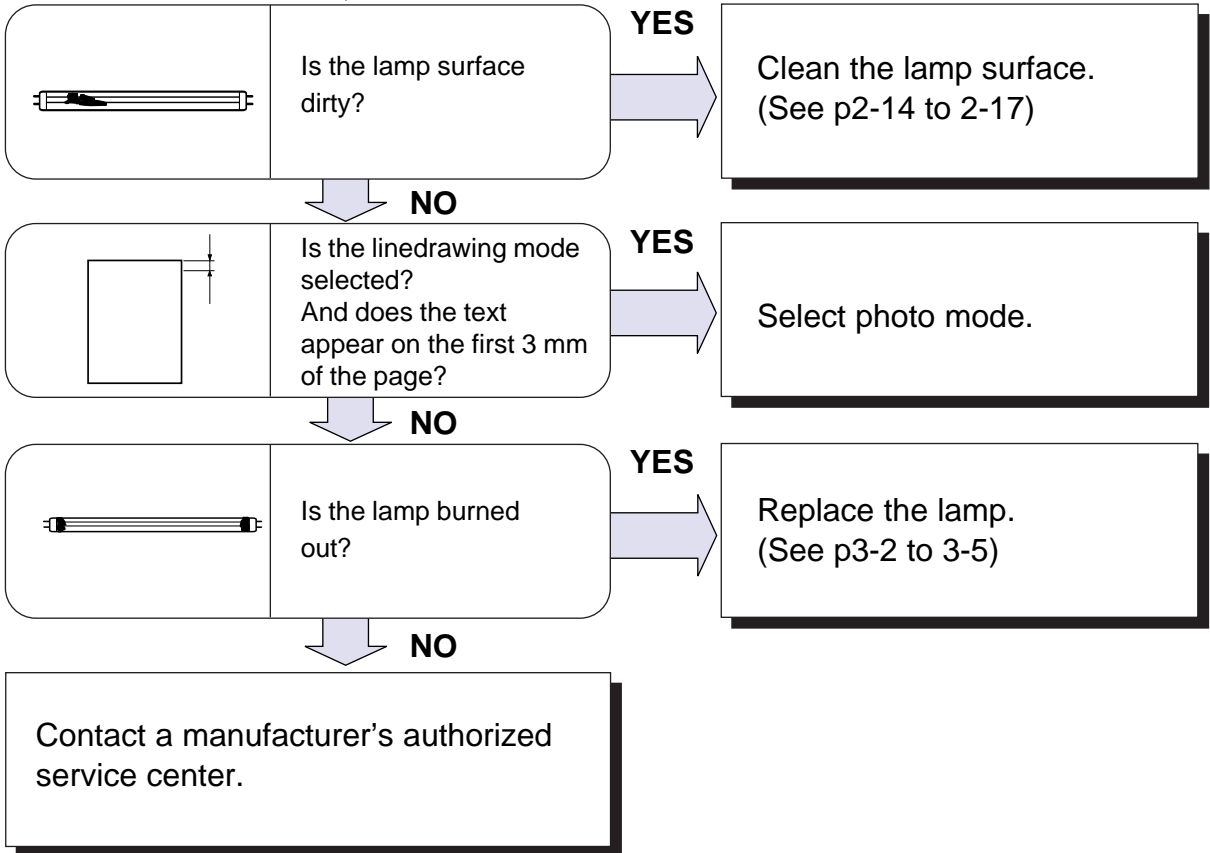

Symptom 6

The CHECK lamp blinks.

Operator panel

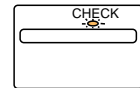

Action depends on the displayed message:
SF2 (SF3) did not detect leading (trailing)
edge of paper

Remove paper and clear the sensors.

Hopper empty

Set the document.

Cover open

Close the side cover.

Close the Endorser cover.

Mis-pick

Go to Symptom 7.

Pick roller unit not set

Set the pick roller unit.

Hopper overload

Reduce document stack in hopper.

Turn the power off once and
on again.

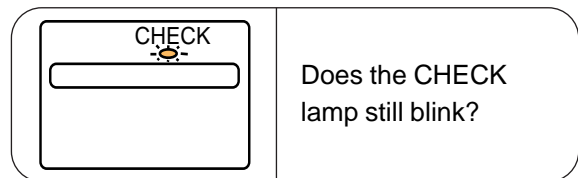

NO

End

YES

Contact a manufacturer's authorized
service center.

Symptom 7

Mis-pick or paper jam frequently occurs.

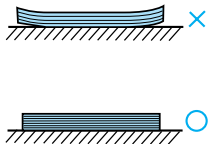

- Does the paper have curled edges?
- Is the paper stack uneven?

YES

Smooth out the curled paper or reduce document stack in hopper.
(See p1-5)

NO

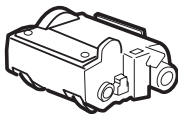

Are pick rollers, separation roller, brake roller, pad or paper path dirty?

YES

Clean the pick rollers, separation roller, brake roller, pad or paper path.
(See Chapter 2)

NO

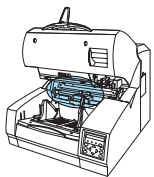

Are the pick roller unit and brake roller in the correct position?

YES

Mount the pick roller unit and brake roller correctly.
(See p3-6 to 3-10)

NO

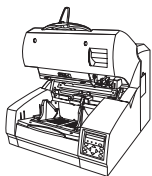

Is the roller worn out?
(See Appendix)

YES

Replace the roller.

NO

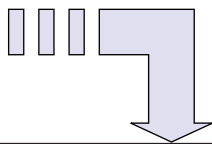

Contact a manufacturer's authorized service center.

Messages and Actions

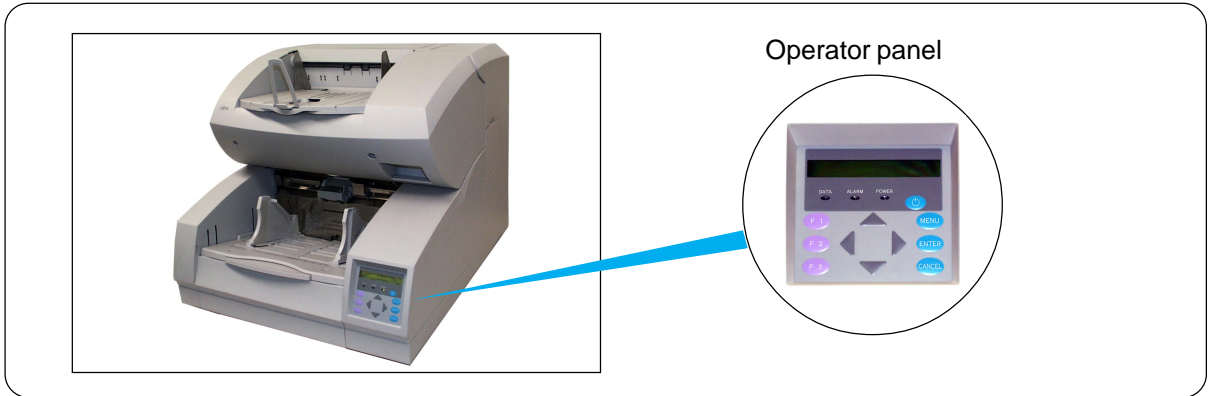

■ Device and Operator Actions for Temporary Errors

If a temporary error is detected in the scanner, (CHECK) lamp at the operator panel blinks.

- | | | |
|---|---|---|
| SF2 (SF3) did not detect leading (trailing) edge of paper | * | Open the upper transport unit and remove the document on the transport path. Close the unit. Return the jammed or double-feed document to the hopper and read it again. |
| Hopper empty | * | Press the CANCEL button or issue the start command. Load documents on the hopper and ENTER reading them. |
| Cover open | — | Close the upper transport unit or the endorser cover. Or the side cover. |
| Mis-pick | * | Open the upper transport unit and remove the document on the transport path. Close the unit. Return the jammed document on the hopper and read it again. |
| Pick roller unit not set | * | Open the upper transport unit and correct the pick roller unit setting. Close the upper transport unit. See "Pick Roller Unit Replacement". |
| Hopper overload | * | Reduce document stack in the hopper. |

*:Press **CANCEL** to reset these errors.

■ Device and Operator Actions for Equipment Errors

If an equipment error is detected in the scanner, the (CHECK) lamp at the operator panel blinks.

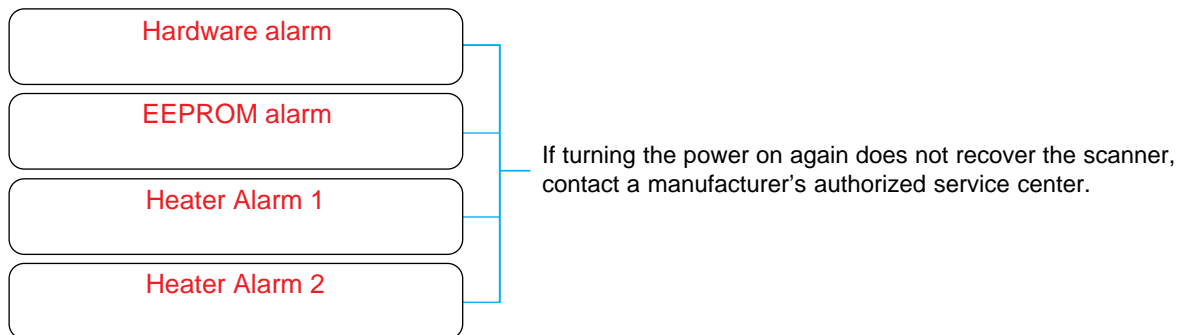
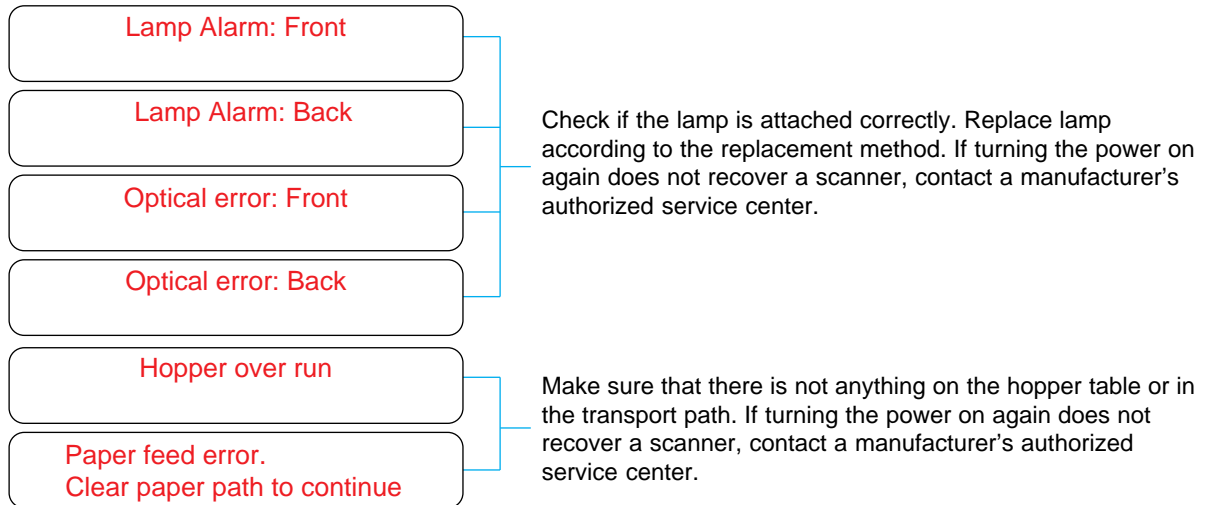

Problem Checklist

Before contacting the manufacturer's authorized service center, please fill in the following items.

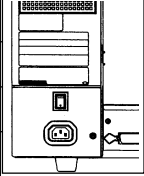
■ General																																			
Model		(Example) M4099D																																	
Part number		(Example) CA04315-B002																																	
Serial number		(Example) 100																																	
Manufactured data		(Example) 2000-02 (ex. Feb. 2000)																																	
Version	<table border="1"> <tr> <td>A</td><td>0</td><td>1</td><td>2</td><td>3</td><td>4</td><td>5</td><td>6</td><td>7</td><td>8</td><td>9</td> </tr> <tr> <td>B</td><td>0</td><td>1</td><td>2</td><td>3</td><td>4</td><td>5</td><td>6</td><td>7</td><td>8</td><td>9</td> </tr> <tr> <td>C</td><td>0</td><td>1</td><td>2</td><td>3</td><td>4</td><td>5</td><td>6</td><td>7</td><td>8</td><td>9</td> </tr> </table>	A	0	1	2	3	4	5	6	7	8	9	B	0	1	2	3	4	5	6	7	8	9	C	0	1	2	3	4	5	6	7	8	9	The version is printed on the version label located at the bottom right of the rear of the equipment. The version is checked with the double line. This example is for A3 version.
A	0	1	2	3	4	5	6	7	8	9																									
B	0	1	2	3	4	5	6	7	8	9																									
C	0	1	2	3	4	5	6	7	8	9																									
Date of purchase																																			
Symptoms																																			
Persistent problem?																																			
Serviced before (when and how)																																			
■ Transport error																																			
Error message if any.																																			
Type of document																																			
What is your daily usage																																			
Date of last cleaning.																																			
Date of the consumable replacement																																			
■ Image error																																			
Interface controller model																																			
Software/application name																																			
Can you send the original and output of the sheet by facsimile?																																			

Appendix

Consumable counter

This scanner is equipped with an internal counter that can be used to monitor the life of your consumable parts. It is recommended that the pick roller unit, brake roller, and pad be replaced every 300,000 sheets or one year when scanning Xerox paper types. This cycle will be shorter if scanning treated paper types such as carbonless paper types.

■ Setting the consumable counter

- 1** Press **MENU** when the LCD displays "Ready". The <<MODE SELECT>> screen appears with SETUP blinking.
- 2** Press **ENTER** twice. The Settings screen appears (or Paper Length Check).
- 3** Press **▶** (→) eleven times. The Consumable Counter screen appears.
- 4** Press **ENTER**. The value of the consumable counter is displayed in ten thousands of sheets.
- 5** Press **▼** (↓) or **▲** (↑). The value changes (001 to 256). Holding down **▼** (↓) or **▲** (↑) speeds up the change. The recommended value is 030.

<<MODE SELECT>>
SETUP BROWSE

<<SETUP MODE>>
Settings

<<SETUP MODE>>
Consumable Counter

Consumable Counter
XXX 0000 sheets

Consumable Counter
XXX 0000 sheets

6 When the desired value is displayed, press **ENTER** to save the value. The Consumable Counter screen appears.

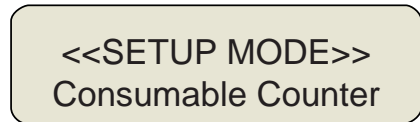

7 Press **CANCEL** twice. The LCD returns to the Ready screen.

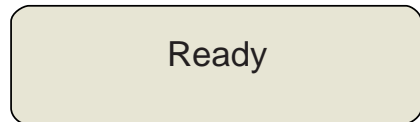

■ Resetting the consumable counter

There is another case in which you may reset the consumable counter. If the scanner detects a consumable life alarm which is displayed when the consumable counter reaches the prescribed value, the LCD indicates an alarm that the consumable may be expired. In this case, press **CANCEL** to proceed the next operation (usually, you reset the counter after replacing the consumable.) The LCD indicates the following message:

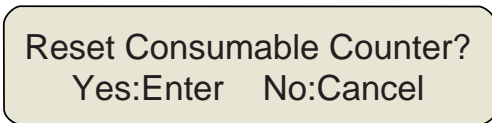

Yes (Enter) : The scanner resets the consumable counter to zero.

No (Cancel) : The scanner does not reset the consumable counter. In this case, the consumable life alarm recurs when the next sheet is fed.

The Fujitsu logo is centered on the page. It features a stylized infinity symbol above the letter 'J' in the word 'FUJITSU'. The text is in a bold, black, sans-serif font. The background of the page consists of a solid dark blue horizontal bar at the top, followed by a series of alternating light blue and white horizontal stripes.

FUJITSU